

Copyright Wärtsilä. All rights reserved. By taking possession of the drawing, the recipient recognizes and honors these rights. Neither the whole nor any part of this drawing may be used in any way for construction, fabrication, marketing or any other purpose nor copied in any way nor made accessible to third parties without the previous written consent of Wärtsilä.

Table of contents

Introduction	1
Abbreviations	1
1 Shaft bearing arrangement / Optimum bearing distances	2
2 Alignment layout calculation (ALC)	4

Introduction

The main engine and propulsion shafts are directly-coupled and thus form one propulsion shaft line which is supported by numerous bearings. The alignment of these bearings has to meet the following basic demands under all normal ship service conditions:

- 1 **all bearings need to have a positive static load;**
- 2 all crankweb deflections need to be within the service limits.

However the machinery foundation is exposed to elastic ship hull bending which depends on draught and trim and also on sea motion. This varies the bearing offsets and thus their static loads. Further influences are service forces and temperatures. To meet the above mentioned basic demands, the following two principles have to be considered:

- It is crucial that the shaft bearings are arranged at optimum long distances in order to limit the effect of the influences which affect the alignment.
- The bearing offset changes which are expected to occur between installation condition and any normal ship service condition need to be considered by an appropriate pre-compensation.

Alignment of a direct-coupled marine propulsion plant is based on a ship design specific alignment layout calculation (ALC) which needs to consider:

- the design of propulsion shaft line
- the design of the vessel
- the influence of ship hull bending
- rules and regulations of the governing bodies (e.g. class)

Abbreviations

The following abbreviations are used in this document:

- ALC alignment layout calculation
 DG design group (Wärtsilä drawing set structure)
 mb engine main bearing
 VLCC very large crude carrier

Substitute for:								PC	Q-Code	X	X	X	X	X
Modif	Number	Drawn Date	Number	Drawn Date	Number	Drawn Date	Number	Drawn Date						
		Product W-2S			Engine Alignment									
					Bearing arrangement & layout calculation									
Made	14.10.2013	J.Bergande	Main Drw.	Page	1 / 13		Material ID	PAAD128843						
Chkd	18.10.2013	W. Schiffer	Design Group	9709		Drawing ID	DAAD040462				Rev			
Appd	21.10.2013	B.Haag												

Copyright Wäertsilä. All rights reserved. By taking possession of the drawing, the recipient recognizes and honors these rights. Neither the whole nor any part of this drawing may be used in any way for construction, fabrication, marketing or any other purpose nor copied in any way nor made accessible to third parties without the previous written consent of Wäertsilä.

1 Shaft bearing arrangement / Optimum bearing distances

As already explained in the introduction, optimum long distances between the shaft line bearings¹ are essential. The maximum and minimum shaft bearing distances are related to the bending stiffness of the shaft which in turn depends on the shaft diameter. The upper and lower limits for the shaft bearing distance are as follows:

- Too long bearing distances increase the risk of bending vibration (whirling).
- Too short bearing distances increase the risk of unloaded or overloaded bearings.

The risk of bending vibration is rather low for direct-coupled propulsion plants driven by W-2S engines - due to the low shaft speed in relation to the large shaft diameters. Anyway, the risk for whirling can be checked by a whirling vibration calculation.

However, the risk for unloaded or overloaded shaft bearings due to too short bearing distances is higher. In case of unloaded shaft bearings, the system will be out of its (approved!) design. The following problems may arise out of it:

- In case of totally unloaded shaft line bearings, the distance between the remaining loaded bearings may become too long and thus the risk of whirling vibration increases.
- In case of a totally unloaded engine main bearing (usually mb #2), the engine is then operated out of design and the risk of main bearing damage² increases.
- An unloaded bearing leads to increased loads for other bearings, which might then become overloaded.

1.1 Guidance for maximum shaft bearing distance

The maximum shaft bearing distance can be calculated according to the following guidance formula³ by putting the outer shaft diameter “d_{shaft}” in millimetres, resulting in the maximum bearing distance “x_{max}” in millimetres:

$$x_{max} = 450 \sqrt{d_{shaft}}$$

Formula 1: guidance formula³ for maximum shaft bearing distance

1.2 Wäertsilä recommendation for intermediate shaft bearing distances

Wäertsilä recommends to arrange the intermediate shaft bearing(s) at the distance “x_{actual}” in a recommended range of

$$65\% x_{max} \leq x_{actual} \leq 90\% x_{max}$$

Formula 2: Wäertsilä recommended range for shaft bearing distance

¹ Also required by class rules.

² The risk of main bearing damage is increased for the unloaded bearing itself and also for other engine main bearings due to increased vibration effects.

³ Formula of GL class. Confirmed by Wäertsilä experience.

Substitute for:								PC	Q-Code	X	X	X	X	X
Modif	Number	Drawn Date	Number	Drawn Date	Number	Drawn Date	Number	Drawn Date						
		Product W-2S			Engine Alignment Bearing arrangement & layout calculation									
Made	14.10.2013	J.Bergande	Main Drw.	Page	2 / 13	Material ID	PAAD128843							
Chkd	18.10.2013	W. Schiffer	Design Group	9709		Drawing ID	DAAD040462					Rev		
Appd	21.10.2013	B.Haag												

If the intermediate bearing(s) is (are) arranged at distances outside the above mentioned recommendation (formula 2)⁴, then:

- the referred installation is not considered as a “standard installation” to which the instructions and guidelines of DG9709 “Engine alignment”⁵ refer to;
- the recommendations⁶ and requirements⁷ for static main bearing loads do not apply;
- the minimum limits of main bearing load for normal ship service⁸ have to be granted anyway;
- it is strongly recommended to contact Wartsila.

Examples:

Table 1 below gives an overview of the recommended optimum bearing distances in relation to mean shaft diameters. However, for a detailed layout please apply formula 2.

Table 1	Recommended intermediate bearing distances [m]	
	min.	max.
Mean shaft diameter		
300 mm	5.1	7.0
400 mm	5.9	8.1
500 mm	6.6	9.0
600 mm	7.2	9.9
700 mm	7.8	10.7
800 mm	8.3	11.4

⁴ This applies in particular for the distance between the foremost shaft bearing and aftmost mb #1.

⁵ See DG9709 - “Engine alignment – Introduction”, section “Validity of instructions and guidelines in DG9709 “Engine alignment”.

⁶ See DG9709 - “Static main bearing loads”, sections “Recommended static main bearing loads for layout calculations of ship new buildings in cold-stopped condition” and “Recommended static main bearing loads before chocking”.

⁷ See DG9709 - “Static main bearing loads”, section “Required static main bearing loads before ship delivery”.

⁸ See DG9709 - “Static main bearing loads”, section “Minimum limits for normal ship service”.

Substitute for:							PC	Q-Code	X	X	X	X	X
-----------------	--	--	--	--	--	--	----	--------	---	---	---	---	---

Modif	Number	Drawn Date	Number	Drawn Date	Number	Drawn Date	Number	Drawn Date
-------	--------	------------	--------	------------	--------	------------	--------	------------

		Product W-2S	Engine Alignment Bearing arrangement & layout calculation				
Made	14.10.2013	J.Bergande	Main Drw.	Page	Material ID		
Chkd	18.10.2013	W. Schiffer	Design Group	3 / 13	PAAD128843		
Appd	21.10.2013	B.Haag		9709			

2 Alignment layout calculation (ALC)

The ALC is created for the condition as expected on board of the vessel during final alignment, i.e. from beginning of the final alignment until chocking and fixation of the main engine.

2.1 Final alignment performed at light draught, cold - stopped

Alignment in new buildings is usually performed in the empty ship and thus at light draught. The main engine and the propulsion shaft components are at approx. ambient temperatures. This condition is considered as “cold – stopped” condition.

Consequently, the static bearing load distribution of the cold - stopped condition in the ALC needs to consider

- the ship condition as mentioned above,
- the expected changes of bearing offsets after final alignment and fixation of main engine and the shaft bearing(s) up to any normal ship service condition.

Thus not any of the following changes which occur after fixation of shaft bearings and main engine may lead to inadmissible bearing loads, i.e.

- neither the elastic ship hull bending from light draught during alignment to maximum draught in service (see section 2.2.1),
- nor the thermal vertical expansion of engine main bearings from ambient temperature during alignment to 55°C in hot service condition,
- nor the maximum propeller forces in service,
- nor the bending moments at the engine integrated thrust bearing⁹.

2.2 Consideration of ship hull bending

2.2.1 Estimation of ship hull bending - based on general experience

Detailed information about ship hull bending to consider in the ALC is usually not available. In such cases general experience about ship hull bending needs to be considered:

An increase of ship draught generally leads to a more hogging shape of the engine and shaft line foundation. This causes a downward bent of the propulsion shafts in relation to the crankshaft and a shift of static loads mainly from mb #2 to aftmost mb #1 – and to a limited degree also from mb #3¹⁰.

The more ship hull bending is expected from light draught during alignment to maximum draught in service, the less load on aftmost mb #1 and the more load on mb #2 has to be adjusted¹¹.

⁹ See section 2.9 regarding calculated zero load for aftmost mb #1 in running conditions.

¹⁰ See DG9709 - “Engine alignment – Main bearing loads – recommendations & limits”, section “Static load distribution for the aft three engine main bearings under consideration of elastic ship hull bending” as well as sub-section “Example for ship hull bending”.

¹¹ See DG9709 - “Engine alignment – Main bearing loads – recommendations & limits”, section “Lower and upper recommended values for aftmost mb #1”.

Substitute for:								PC	Q-Code	X	X	X	X	X
Modif	Number	Drawn Date	Number	Drawn Date	Number	Drawn Date	Number	Drawn Date						
		Product W-2S			Engine Alignment Bearing arrangement & layout calculation									
Made	14.10.2013	J.Bergande	Main Drw.	Page	4 / 13	Material ID	PAAD128843							
Chkd	18.10.2013	W. Schiffer	Design Group	9709		Drawing ID	DAAD040462					Rev		
Appd	21.10.2013	B.Haag												

Copyright Wartsilä. All rights reserved. By taking possession of the drawing, the recipient recognizes and honors these rights. Neither the whole nor any part of this drawing may be used in any way for construction, fabrication, marketing or any other purpose nor copied in any way nor made accessible to third parties without the previous written consent of Wartsilä.

For most ship designs it is expected that the bending of the machinery foundation at maximum draught differs most from the bending at light draught during final alignment. However, the hulls of large and fast container vessels may show the largest difference in bending of the machinery foundation at approx. design draught.

The following exemplary ship hull bending can be expected:

- VLCC and very large bulk carriers show the most hull bending due to the huge difference between ballast and scantling draught. Static loads just above zero should be adjusted for aftmost mb #1 in cold – stopped condition of the ALC and accordingly during final alignment at light draught.
- Large container vessels show a significant hull bending (probably most at approx. service draught), but less than VLCC and very large bulk carriers.
- Feeder container vessels, multi-purpose vessels, general cargo vessels show an average hull bending.
- Gas tankers have a quite limited hull bending.
- Car carriers and livestock carriers have only a very limited hull bending.

Example for ship hull bending

The following figure 1 shows a typical lowering of the propulsion shaft line of an Aframax tanker (100 000 dwt) at increasing draught from light draught at final alignment and chocking and fixation, via ballast draught up to maximum draught (scantling).

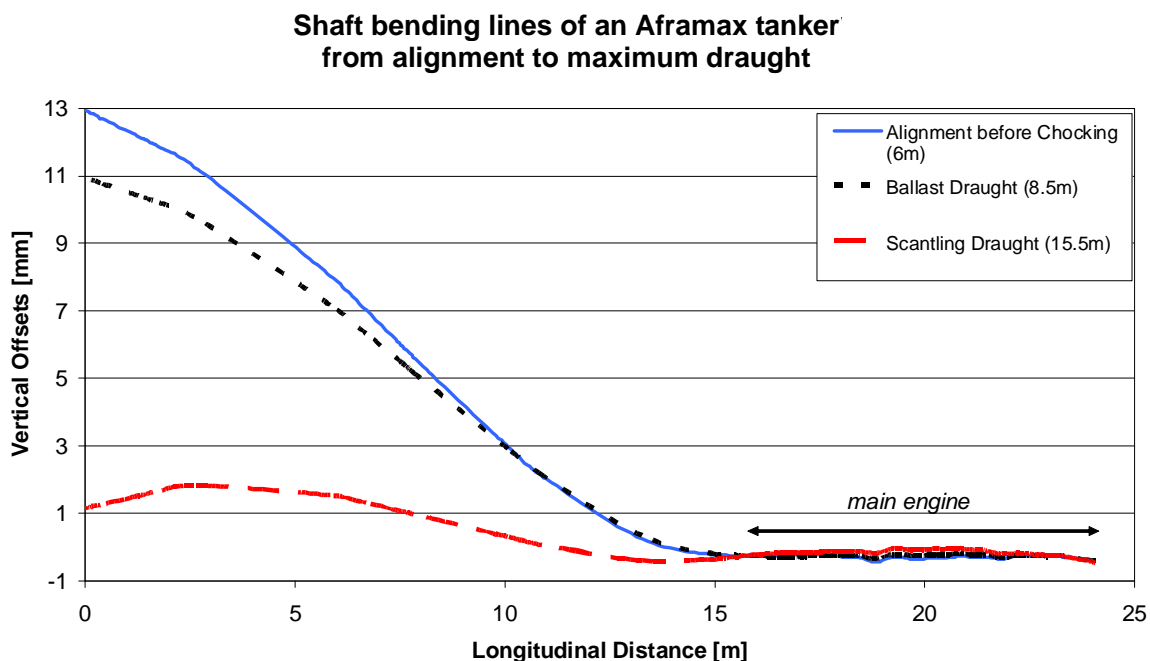

Figure 1: lowering of propulsion shaft due to hull bending (hogging) at increasing draught.

Substitute for:										PC	Q-Code	X	X	X	X	X
Modif	Number	Drawn Date	Number	Drawn Date	Number	Drawn Date	Number	Drawn Date	Number	Drawn Date						
		Product W-2S			Engine Alignment Bearing arrangement & layout calculation											
Made	14.10.2013	J.Bergande	Main Drw.	Page	5 / 13	Material ID	PAAD128843									
Chkd	18.10.2013	W. Schiffer	Design Group	Drawing ID		DAAD040462			Rev							
Appd	21.10.2013	B.Haag	9709													

Copyright Wärtsilä. All rights reserved. By taking possession of the drawing, the recipient recognizes and honors these rights. Neither the whole nor any part of this drawing may be used in any way for construction, fabrication, marking or any other purpose nor copied in any way nor made accessible to third parties without the previous written consent of Wärtsilä.

The effect on the aft main bearings can be clearly seen in the following magnification of the previous figure.

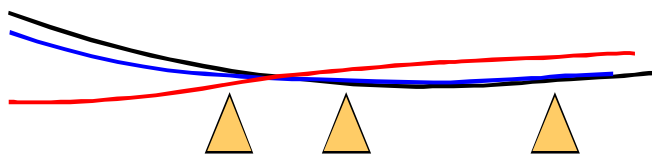

Figure 2: magnification of shaft line bending due to hull bending at the aft three engine main bearings.

At light draught condition, aftmost mb #1 is very low loaded and in contrast mb #2 is very well loaded.

At maximum draught condition the above mentioned static load distribution has inverted. The corresponding calculated main bearing load distribution¹² for each of the three conditions are shown in figure 3 below.

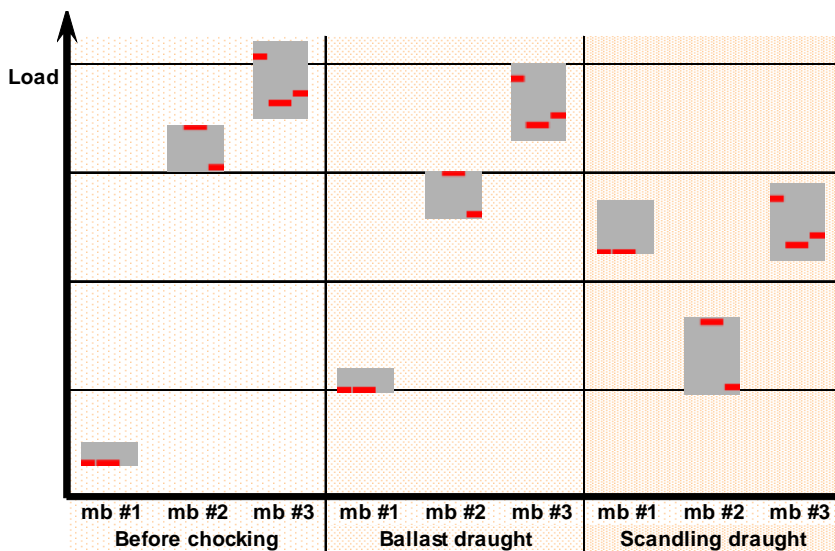

Figure 3: overview of static main bearing load distribution at different draught conditions. When the ship draught increases, then also the static load on mb #1 increases and in contrast static load on mb #2 decreases¹³.

¹² Further explanations on how to understand this illustration are provided in DG9709 - "Engine alignment – Guidelines for measurements" - section "Influence of crank angle on bearing load".

¹³ See also DG9709 - "Engine alignment – Main bearing loads – recommendations & limits" - section "Static load distribution for the aft three engine main bearings under consideration of elastic ship hull bending".

In general, **mb #2** is most critical: It **must not be unloaded at any draught up to scantling or design draught**.

Substitute for:							PC	Q-Code	X	X	X	X	X
Modif	Number	Drawn Date	Number	Drawn Date	Number	Drawn Date	Number	Drawn Date					
		Product W-2S			Engine Alignment Bearing arrangement & layout calculation								
Made	14.10.2013	J.Bergande	Main Drw.	Page	6 / 13	Material ID	PAAD128843						
Chkd	18.10.2013	W. Schiffer	Design Group	9709		Drawing ID	DAAD040462				Rev		
Appd	21.10.2013	B.Haag											

2.2.2 Consideration of hull bending data if provided

In those cases where data of ship hull bending are provided, the ALC needs to be carried out at least for the following conditions:

- alignment condition (new buildings usually at light draught)
- ballast draught
- design draught
- maximum draught

The calculated static main bearing loads for each of the service related draught condition must fulfil the minimum limits required for normal ship service¹⁴. However, it is not necessary to consider the recommended bearing loads which are provided by instruction DG9709 - "Engine alignment – Main bearing loads".

2.3 Bending vibration calculation (whirling)

Whirling calculations might be required e.g. by the classification society or other involved parties. Wärtsilä recommends to perform whirling calculations in the following cases:

- if bearing distances exceed the normal maximum limit (see section 1.2, formula 2);
- if very low loaded shaft bearings (less than 15% of design load) have been calculated in ALC
- if a shaft generator or shaft motor is installed;
- if no forward stern tube bearing is installed.

2.4 Calculation basics and definitions

Independent of which alignment calculation program is used, the following basics need to be taken into account:

- Stiffness of all bearings, i.e. shaft bearings as well as engine main bearings. The stiffness of structure without oil film needs to be considered for each bearing support, since jack-up tests are performed in stopped condition.
- Bearing clearance, at least for the engine main bearings, as otherwise a low loaded main bearing might be calculated with negative load in some of the calculated conditions.
- The shaft line model used in the calculation program has to provide a realistic picture of the real installation.
- If the EnDyn alignment program is used, then also the real shaft bearing load measurement positions should be included, as this allows calculating the expected jack-load curves. A direct comparison between the jack-load curves calculated in the ALC and the curves of plotted bearing load measurement results (so called 'jack-up tests') is possible. This is very useful to evaluate the alignment.

¹⁴ See DG9709 - "Engine alignment – Main bearing loads", section "Minimum limits for normal ship service"

Substitute for:								PC	Q-Code	X	X	X	X	X
Modif	Number	Drawn Date	Number	Drawn Date	Number	Drawn Date	Number	Drawn Date						
		Product W-2S			Engine Alignment Bearing arrangement & layout calculation									
Made	14.10.2013	J.Bergande		Main Drw.	Page	Material ID PAAD128843								
Chkd	18.10.2013	W. Schiffer		Design Group	7 / 13									
Appd	21.10.2013	B.Haag		9709	Drawing ID	DAAD040462						Rev		

The definitions used in the calculation need to be clear:

- The definition of gap & sag, e.g. sag referring **either to the centre line or to the top or bottom sides of flanges**. This consideration is crucial if the coupling flange pair has different diameters.
- The definition of calculation reference line (also called “datum line”). It is defined e.g. either by the centre of stern tube or by the forward and aft stern tube bearing support points, or by the main engine position, etc.
- The **definition of bearing offsets**, e.g. the **vertical distance between calculation reference line and the centre line of the unloaded bearing bore with clearance (Wärtsilä default)**.

2.5 Integrated engine models in Wärtsilä’s alignment program EnDyn

It is strongly recommended to use the EnDyn calculation program for ALC of Wärtsilä two-stroke diesel engines, as it provides accurate and detailed results. The program incorporates the full three-dimensional FE based models of all actual portfolio engines, i.e. W-X, RT-flex and RTA type. No further modelling by the user is required, only the correct crankshaft type needs to be selected.

Before starting a new project, it should be ensured that the latest release of the EnDyn program is used. The EnDyn calculation program can be ordered by licensees and shipyards free of charge¹⁵.

2.6 Calculation for cold – stopped condition

This is the calculation which provides the data for final alignment of propulsion shafts and main engine in the ship (see section 2.1).

At the same condition, also the alignment measurements before chocking and fixation need to be done.

Additional conditions which are contained in the ALC are calculated for verifying relevant alignment results.

2.7 Static load distribution of the aft three main bearings

As stated in section 2.2.1 , the influence of ship hull bending on the bearing loads due to increasing draught needs to be pre-compensated by adjusting the appropriate bearing load distribution in the ALC and also during the alignment process.

Based on general experience it is expected that static load will be transferred mainly from mb #2 to aftmost mb #1 – and to a limited degree also from mb #3.

The expected extent of this static load shift depends on the shaft arrangement and on the vessel type, i.e.:

- the closer the distance between aftmost mb #1 and the foremost shaft bearing, the more shift of static load is expected;
- the bigger the difference between maximum ship draught and the draught during final alignment, the more shift of static load is expected.

¹⁵ See DG9709 - “Engine alignment – Introduction”, section “Wärtsilä alignment services”.

Substitute for:								PC	Q-Code	X	X	X	X	X
Modif	Number	Drawn Date	Number	Drawn Date	Number	Drawn Date	Number	Drawn Date						
		Product W-2S			Engine Alignment Bearing arrangement & layout calculation									
Made	14.10.2013	J.Bergande	Main Drw.	Page	8 / 13	Material ID	PAAD128843							
Chkd	18.10.2013	W. Schiffer	Design Group	9709		Drawing ID	DAAD040462					Rev		
Appd	21.10.2013	B.Haag												

Copyright: Wärtsilä. All rights reserved. By taking possession of the drawing, the recipient recognizes and honors these rights. Neither the whole nor any part of this drawing may be used in any way for construction, fabrication, marketing or any other purpose nor copied in any way nor made accessible to third parties without the previous written consent of Wärtsilä.

The higher the expected shift of static loads from mb2 to aftmost mb #1, the lower static load should be adjusted on aftmost mb #1. This is considered by provision of recommended lower and upper values for aftmost mb #1¹⁶.
 Figure 4 below gives a general overview on the recommended bearing load¹⁷ distribution between mb #1 to mb #3.

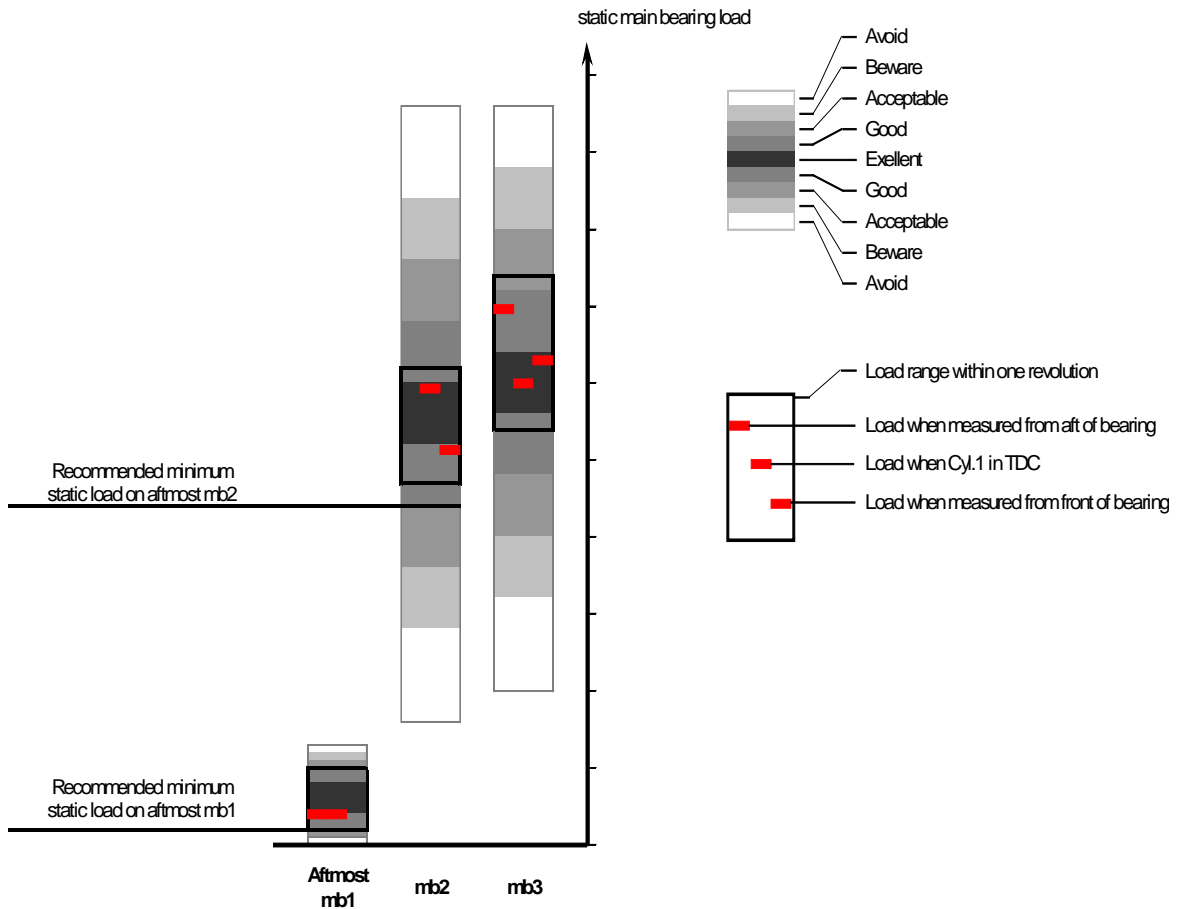

Figure 4: illustration of recommended static main bearing loads for ALC at “cold - stopped” condition.

The recommended static load distribution for the aft three main bearings of new buildings at light draught can also be expressed according to formula 3:

$$F_{stat}(mb\#1) \ll F_{stat}(mb\#2) \leq 1.25 * F_{stat}(mb\#3)$$

Formula 3: Recommended static load distribution for ALC at “cold - stopped” condition

¹⁶ See DG9709 - “Engine alignment – Main bearing loads – recommendations & limits”, section “Lower and upper recommended values for aftmost mb #1”.

¹⁷ Further information regarding the indicated load range box and the red lines therein is provided in DG9709 - “Engine alignment – Guidelines for measurements” - section “Influence by the crank angle in actual measurement position”.

Substitute for:							PC	Q-Code	X	X	X	X	X
Modif	Number	Drawn Date	Number	Drawn Date	Number	Drawn Date	Number	Drawn Date					
			Product W-2S			Engine Alignment Bearing arrangement & layout calculation							
Made	14.10.2013	J.Bergande	Main Drw.	Page	9 / 13	Material ID	PAAD128843						
Chkd	18.10.2013	W. Schiffer	Design Group	9709			Drawing ID	DAAD040462				Rev	
Appd	21.10.2013	B.Haag											

Copyright: Wärtsilä. All rights reserved. By taking possession of the drawing, the recipient recognizes and honors these rights. Neither the whole nor any part of this drawing may be used in any way for construction, fabrication, marketing or any other purpose nor copied in any way nor made accessible to third parties without the previous written consent of Wärtsilä.

2.7.1 Recommended static main bearing loads, alignment layout calculation condition

The **recommended static load distribution** for the aft three main bearings for new buildings are **provided as guidance**.

They refer to the usual condition at final alignment, i.e. the new built **ship is floating at light ballast draught and the engine is in cold - stopped condition**¹⁸.

The final alignment process needs to aim for achieving a static load distribution for mb #1 to mb #3 which is **very similar** to that which is provided by the cold – stopped condition of the ALC.

However it is hardly possible to adjust the main bearing static loads exactly according to the referred loads of the ALC for the following reasons:

The very close distances among the main bearings in relation to the crankshaft bending stiffness result in a very high sensitivity of static main bearing loads for offset variations. This is indicated by very high so called ‘bearing influence numbers’¹⁹.

Static main bearing load data for design (ALC) are provided in DG9709 - “Engine alignment – Main Bearing Loads – Recommendations & Limits“, section “Recommended static main bearing loads for design of ship new buildings, cold - stopped condition”

2.8 Calculation for hot – stopped condition

The ALC for hot - stopped condition considers the thermal rise of the engine main bearings²⁰ and thus provides information about the sensitivity of the shafting system regarding the thermal rise “ Δh_{mb} ” of the engine main bearings.

If the changes between the cold and hot condition result in critical - or even in inadmissible bearing loads, then

- either the static load distribution in cold – stopped condition needs to be re-adjusted
- or the shaft arrangement needs to be checked and optimized as explained in section 1 .

¹⁸ For ALC only the cold - stopped condition should comply with the recommended bearing loads.

¹⁹ Bearing influence numbers indicate the theoretical change of static bearing loads due to a change in vertical bearing offset. This information is provided by the ALC.

²⁰ Considering also the thermal rise of the shaft bearings is optional. However, as the distances between the shaft bearings are quite long, this influence can usually be neglected. Otherwise, the shaft bearing thermal rise has to be considered in the same way as described for the engine main bearings.

Substitute for:								PC	Q-Code	X	X	X	X	X
Modif	Number	Drawn Date	Number	Drawn Date	Number	Drawn Date	Number	Drawn Date						
		Product W-2S			Engine Alignment Bearing arrangement & layout calculation									
Made	14.10.2013	J.Bergande	Main Drw.	Page	10 / 13	Material ID	PAAD128843							
Chkd	18.10.2013	W. Schiffer	Design Group	9709		Drawing ID	DAAD040462					Rev		
Appd	21.10.2013	B.Haag												

Copyright Wärtsilä. All rights reserved. By taking possession of the drawing, the recipient recognizes and honors these rights. Neither the whole nor any part of this drawing may be used in any way for construction, fabrication, marketing or any other purpose nor copied in any way nor made accessible to third parties without the previous written consent of Wärtsilä.

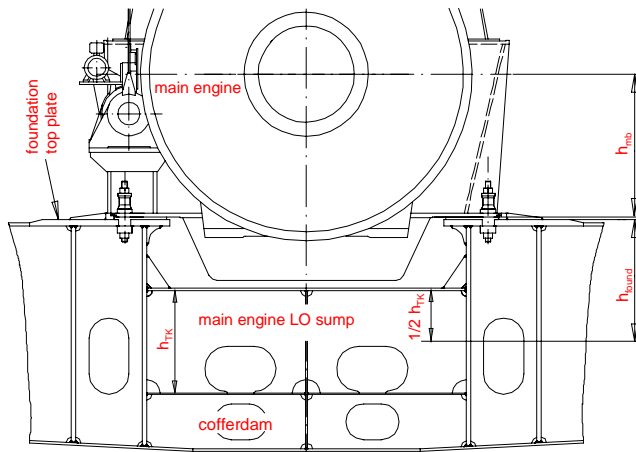

Figure 5: heights for calculating the thermal rise of the engine main bearings.

The thermal rise of main bearing offsets is calculated with formula 4 (dimensions in [mm]) if the case specific height “h_{found}” according to figure 5 is known:

$$\Delta h_{mb} = (h_{mb} + h_{found}) \times C \times \frac{11.5 \times (t_{eng} - t_{ref})}{10^6}$$

Formula 4: thermal rise of main bearings considering “h_{found}” if available.

If “h_{found}” is not available at the stage of ALC preparation, then the thermal rise of main bearing offsets can be calculated according to formula 5 (dimensions in [mm]):

$$\Delta h_{mb} \approx h_{mb} \times D \times \frac{11.5 \times (t_{eng} - t_{ref})}{10^6}$$

Formula 5: thermal rise of main bearings if “h_{found}” is un-available.

Δh_{mb}	[mm]	common thermal rise of engine main bearings from cold to hot condition
h_{mb}	[mm]	height between bedplate bottom and crankshaft centre line
h_{found}	[mm]	height from the middle of the LO sump tank below main engine to the top plate of the engine foundation
C	[-]	correction factor ²¹ , usually between 0.3 and 0.5: to be applied according to shipyard’s experience with current ship design. If no experience is available, 0.4 should be applied (Wärtsilä default).
D	[-]	correction factor for simplified calculation of thermal rise: 0.75
t_{eng}	[°C]	engine operating temperature (default: 55°C)
t_{ref}	[°C]	reference temperature during alignment for foundation, shaft bearing supports and engine (default: 20°C)

²¹ The correction factor considers also the simultaneous hogging of engine due to temperature differences. This reduces the effect of the common thermal rise of engine main bearings.

Substitute for:							PC	Q-Code	X	X	X	X	X
Modif	Number	Drawn Date	Number	Drawn Date	Number	Drawn Date	Number	Drawn Date					
			Product W-2S			Engine Alignment Bearing arrangement & layout calculation							
Made	14.10.2013	J.Bergande	Main Drw.	Page	11 / 13	Material ID	PAAD128843						
Chkd	18.10.2013	W. Schiffer	Design Group	9709		Drawing ID	DAAD040462			Rev			
Appd	21.10.2013	B.Haag											

Example for Wärtsilä RT-flex50-D engines:

h_{mb}	1088 mm
h_{found}	1090 mm
C	0.4
t_{ref}	20°C

$$\Delta h_{mb} = (1088 + 1090) \times 0.4 \times \frac{11.5 \times (55 - 20)}{10^6}$$

$$\Delta h_{mb} = 0.35\text{mm}$$

2.9 Calculation for hot - running condition

The ALC for the hot - running condition considers the following service-related forces and moments:

- the thermal rise of the engine main bearings
- the maximum axial propeller thrust
- the maximum bending moment at the propeller due to the propeller thrust eccentricity
- the maximum bending moment at the thrust bearing due to the thrust bearing eccentricity.

This calculation is an important verification of the shaft bearing load distribution which must show acceptable static loads also under the influence of the following service related forces:

- The bending moment produced by the propeller thrust eccentricity will mainly shift static bearing load from the aft stern tube bearing to the 2nd aft shaft bearing²². Also some minor changes on the more forward bearings can be seen. In addition the angular misalignment of propeller shaft inside the aft stern tube bearing will change and to a reduced extent also inside the forward stern tube bearing (if exist).
- The bending moment produced by the thrust bearing eccentricity at ahead thrust will mainly shift the static load from aftmost mb #1 to mb #2 and mb #3. Depending on its distance to the main engine, also a load reduction on the foremost shaft bearing might be seen²³.

The calculated static loads in running condition need to be checked:

- The **shaft bearings must have positive static loads** within the allowable range.
- **Aftmost mb #1 can be unloaded (as per common use in most ALC** which consider the bending moment at the thrust bearing) - **but it MUST NOT have a negative static load.**

²² Either to the forward stern tube bearing (if exist) or to the (aft) intermediate bearing resp. (if no forward stern tube bearing is installed).

²³ The closer the distance between foremost shaft bearing and main engine, the higher the static load reduction at the foremost shaft bearing which is caused by the bending moment at thrust bearing at ahead propeller thrust.

Substitute for:								PC	Q-Code	X	X	X	X	X
Modif	Number	Drawn Date	Number	Drawn Date	Number	Drawn Date	Number	Drawn Date						
			Product W-2S		Engine Alignment Bearing arrangement & layout calculation									
Made	14.10.2013	J.Bergande	Main Drw.	Page	12 / 13	Material ID	PAAD128843							
Chkd	18.10.2013	W. Schiffer	Design Group	9709		Drawing ID	DAAD040462						Rev	
Appd	21.10.2013	B.Haag												

Copyright Wäartsilä. All rights reserved. By taking possession of the drawing, the recipient recognizes and honors these rights. Neither the whole nor any part of this drawing may be used in any way for construction, fabrication, marking or any other purpose nor copied in any way nor made accessible to third parties without the previous written consent of Wäartsilä.

- **Mb #2 to foremost mb #(n) must have positive static loads.**

It needs to be born in mind that the full propeller thrust can only develop at approx. design draught condition or above. However, the full propeller thrust cannot be developed at light draught condition or at partial propeller immersion.

Consequently ALC results which consider the design or maximum propeller thrust and simultaneously refer bearing offsets at ballast draught or partly immersed propeller can only provide a general indication regarding the safety margin of the installation.

Substitute for: PC Q-Code X X X X X

Modif	Number	Drawn Date	Number	Drawn Date	Number	Drawn Date	Number	Drawn Date

		Product W-2S		Engine Alignment Bearing arrangement & layout calculation																			
		<table border="1"> <tr> <td>Made</td> <td>14.10.2013</td> <td>J.Bergande</td> <td>Main Drw.</td> <td>Page</td> <td colspan="2">Material ID</td> </tr> <tr> <td>Chkd</td> <td>18.10.2013</td> <td>W. Schiffer</td> <td>Design Group</td> <td>13 / 13</td> <td colspan="2">PAAD128843</td> </tr> <tr> <td>Appd</td> <td>21.10.2013</td> <td>B.Haag</td> <td>9709</td> <td>Drawing ID</td> <td colspan="2">DAAD040462</td> </tr> </table>						Made	14.10.2013	J.Bergande	Main Drw.	Page	Material ID		Chkd	18.10.2013	W. Schiffer	Design Group	13 / 13	PAAD128843		Appd	21.10.2013
Made	14.10.2013	J.Bergande	Main Drw.	Page	Material ID																		
Chkd	18.10.2013	W. Schiffer	Design Group	13 / 13	PAAD128843																		
Appd	21.10.2013	B.Haag	9709	Drawing ID	DAAD040462																		

WinGD-2S - Guidelines for layout calculation

TRACK CHANGES

DATE	SUBJECT	DESCRIPTION
2016-10-25	DOCUMENT	First web upload

DISCLAIMER

© Copyright by Winterthur Gas & Diesel Ltd.

All rights reserved. No part of this document may be reproduced or copied in any form or by any means (electronic, mechanical, graphic, photocopying, recording, taping or other information retrieval systems) without the prior written permission of the copyright owner.

THIS PUBLICATION IS DESIGNED TO PROVIDE AN ACCURATE AND AUTHORITATIVE INFORMATION WITH REGARD TO THE SUBJECT-MATTER COVERED AS WAS AVAILABLE AT THE TIME OF PRINTING. HOWEVER, THE PUBLICATION DEALS WITH COMPLICATED TECHNICAL MATTERS SUITED ONLY FOR SPECIALISTS IN THE AREA, AND THE DESIGN OF THE SUBJECT-PRODUCTS IS SUBJECT TO REGULAR IMPROVEMENTS, MODIFICATIONS AND CHANGES. CONSEQUENTLY, THE PUBLISHER AND COPYRIGHT OWNER OF THIS PUBLICATION CAN NOT ACCEPT ANY RESPONSIBILITY OR LIABILITY FOR ANY EVENTUAL ERRORS OR OMISSIONS IN THIS BOOKLET OR FOR DISCREPANCIES ARISING FROM THE FEATURES OF ANY ACTUAL ITEM IN THE RESPECTIVE PRODUCT BEING DIFFERENT FROM THOSE SHOWN IN THIS PUBLICATION. THE PUBLISHER AND COPYRIGHT OWNER SHALL UNDER NO CIRCUMSTANCES BE HELD LIABLE FOR ANY FINANCIAL CONSEQUENTIAL DAMAGES OR OTHER LOSS, OR ANY OTHER DAMAGE OR INJURY, SUFFERED BY ANY PARTY MAKING USE OF THIS PUBLICATION OR THE INFORMATION CONTAINED HEREIN.