

## X62-B

## IMO Tier II/Tier III (SCR)

<b>Cylinder bore:</b>	620mm
<b>Piston stroke:</b>	2658mm
<b>Speed:</b>	77-103rpm
<b>Mean effective pressure at R1:</b>	21bar
<b>Stroke/bore ratio:</b>	4.29

### Rated power, principal dimensions and weights

Cyl.	Output in kW at				Length A mm	Dry mass tonnes
	103rpm		77rpm			
	R1	R2	R3	R4		
5	14500	10650	10800	7950	7000	325
6	17400	12780	12960	9540	8110	377
7	20300	14910	15120	11130	9215	435
8	23200	17040	17280	12720	10320	482

Dimensions mm	B	C	D
	4200	1360	9580
	F1	F2	F3
11830	11830	11005	2110

### Brake specific fuel consumption (BSFC) in g/kWh

Rating point	R1	R2	R3	R4
BMEP, bar	21	15.5	21	15.4
BSFC (g/kWh) Delta Bypass Tuning, 100% power, Tier II	167.8	162.3	166.8	162.3

R1 BSFC (g/kWh), Tier II	Power(%)				
	50	65	75	90	100

Rating point		R1	R2	R3	R4
Delta Bypass Tuning	160.7	158.8	159.3	162.1	167.8
Low-load Tuning	160.7	155.3	159.3	162.5	168.8

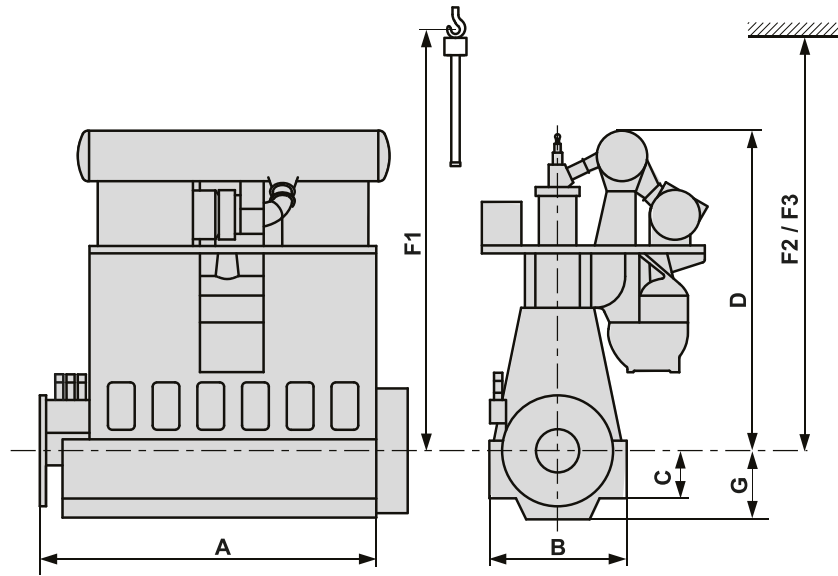

# Engine Definitions and Notes

## ISO Standard (ISO 3046-1) reference conditions

1.0 bar Total barometric pressure at R1

25°C Suction air temperature

30% Relative humidity

25°C Cooling water temperature before engine

## Rating points

The engine layout fields for WinGD low-speed engines are defined by the power/speed rating points R1, R2, R3 and R4 (see diagram below).

R1, or instead if applicable, is the nominal maximum continuous rating (MCR).



Any power and speed within the respective engine layout field may be selected as the Contracted-MCR (CMCR) point for an engine.

## Dimensions and weights

- All dimensions and weights are not binding. For detailed information and updates, please visit: [www.wingd.com/en/engines/engine-types](http://www.wingd.com/en/engines/engine-types)

A Engine length from the coupling flange to the end of the bedplate

A\* Engine length from the TC aft end to the end of the bedplate

B Width of the engine seating

C Dist. from the centre of the crankshaft to the underside of the foot flange

D Dist. from the centre of the crankshaft to the highest point of the engine

F1 Min. height for vertical removal of the piston

F2 Min. height for vertical removal of the piston with double-jib crane

F3 Min. height for tilted removal of the piston with double-jib crane

G Distance from the centre of the crankshaft to the lowest point of the engine

- The engine weight is a net value and excludes any liquids.

## Fuel/energy consumption

All brake specific fuel consumptions (BSFC) and brake specific pilot fuel consumptions (BSPC) are quoted for fuel of lower calorific value 42.7 MJ/kg.

Brake specific gas consumptions (BSGC) are quoted for gas of lower calorific value 50.0 MJ/kg.

For other fuel types, the following reference lower calorific values are applied:

Ammonia	18.6MJ/kg
LPG	46.0MJ/kg
Methanol	19.9MJ/kg
Ethanol	26.8MJ/kg

Brake specific energy consumptions (BSEC) for dual-fuel engines are based on energy delivered to the engine as gas and liquid fuel for one kilowatt hour mechanical power output.

For all WinGD low-speed diesel and dual-fuel engines stepwise tolerances have been introduced for the brake specific fuel and energy consumption (BSFC/BSEC) guarantee, referring to ISO standard reference conditions (ISO 15550 and 3046):

- +5% tolerance for 100% to 85% engine power
- +6% tolerance for <85% to 65% engine power
- +7% tolerance for <65% to 50% engine power

The BSFC/BSEC guarantee is possible at up to three power points between 50–100%.

## Available engine tunings

Delta Bypass Tuning and Low-load Tuning are available for certain WinGD low-speed diesel engines to provide optimum fuel consumption for different engine loads. Delta Bypass Tuning and Low-load Tuning focuses on reducing fuel consumption in the operating range below 90% or 75% engine power.

The advanced technology of Steam Production Control (SPC) can be added to the Low-load and Delta Bypass Tuning to increase the steam production, while keeping the overall fuel consumption at a minimum.

Dual tuning is available on request and in cooperation with classification societies.

Automated Sequential Turbocharging (aSTC) is available as an option for X82-2.0 and X92-B engines with multi-turbocharger configurations. aSTC significantly reduces the engine's consumption at low loads.



# Engine Designation

## 6X52DF-A-S1.0



Example engine designation 6X52DF-A-S1.0 representing a WinGD 6 cylinder, short-stroke engine for dual-fuel operation with ammonia and diesel.

All data provided in this booklet is for information purposes only, explicitly non-binding and subject to change without notice. The General Technical Data (GTD) program provides up-to-date information on WinGD low-speed engines.

When referring to specific engines, the data may be subject to changes. These will be assessed individually according to the particular characteristic of each project.